

# Human Steady-State Visual and Auditory Evoked Potential Components During a Selective Discrimination Task

Thomas F. Collura, Ph.D., P.E.

*Human steady-state visual and auditory evoked potentials were measured during a sequence of visual and auditory discrimination tasks requiring attention, and the detection of just-noticeable differences in stimulus intensity. Both stimuli were always present, and visual and auditory evoked potentials were measured simultaneously. Evoked potentials were measured by synchronous filtering of the EEG at the stimulus fundamental and its first harmonic. The experiment alternated visual and auditory discrimination tasks in a manner designed to demonstrate the effects of attention shifts, separate from changes in general alertness or arousal. Confirming prior studies, auditory evoked potentials were found to be insensitive to directed attention shifts. However, visual evoked potential correlates of directed attention were found in some subjects. Considerable inter-subject variability was found, suggesting differences in cognitive style or strategies during the task. This method appears to be useful in studying short-term effects in evoked potentials as a function of attention, alertness, and time effects.*

## Introduction

The use of sensory evoked brain potentials in the study of attention and cognitive processing has a long history (Naatanen, 1975; Regan, 1989; Spong, Haider, & Lindsley, 1965). Previous studies have made extensive use of "transient" evoked potentials, which are computed by averaging a large number of repetitive responses to separate the desired signal from concurrent "noise." While this technique has provided some insight into the brain mechanisms, it has the fundamental inability to track short-term changes in brain state. This is because the raw responses must be measured over a period of many seconds or minutes; during this time, changes due to attention, alertness, or other short-term modulations cannot in themselves be measured. On the contrary, such changes introduce signal variance which further degrades the accuracy of the final evoked potential estimate.

Several techniques are available for measuring evoked responses in a more rapid manner (McGille & Aunon, 1977; Vaz &

Thakor, 1989). One which is well suited to real-time brain monitoring is synchronous filtering of steady-state evoked potentials (Collura, 1990). This technique has been extensively explored from a purely psychophysical standpoint; however, its application to cognitive monitoring is as of yet unexplored (Regan, 1989). Linden, Picton, Hamil, and Campbell (1987) performed a study of auditory steady-state evoked potentials in this application, with negative results. This report describes preliminary studies which demonstrate the feasibility of using real-time steady-state visual evoked potentials for the monitoring of short-term shifts in brain responsivity.

Generally, steady-state evoked potentials are understood in terms of nonlinear mechanisms which involve both "driving" phenomena and the production of harmonics from a pure sinusoidal input (Childers & Perry, 1971). According to this interpretation, the evoked response is said to be nonlinear because of the presence of higher-order harmonics, plus the appearance of

“resonance” phenomena observed near the alpha frequency.

However, an alternative interpretation is possible when study is limited to the responses to discrete stimuli such as brief clicks or flashes. In this case, a predominant mechanism leading to the evoked response is the linear superposition of successive discrete responses, to produce a complex periodic wave. This will be valid as long as successive stimuli arrive at intervals large enough for the recovery function to be near 100%, typically 100 msec or more (Kinney, McKay, Mensch, & Luria, 1973; van Hof, 1960).

Mathematically, if a single evoked response is represented as  $ep(t)$ , a train of stimuli is represented as  $s(t)$  and the steady-state evoked response as  $ssep(t)$ , the following two relations apply:

$$ssep(t) = ep(t) * s(t)$$

$$S_{ssep}(j\omega) = S_{ep}(j\omega) \cdot S_s(j\omega)$$

where  $*$  denotes linear convolution, and  $S_{ssep}$ ,  $S_{ep}$ , and  $S_s$  are the power spectra (magnitude-squared Fourier Transform) of their corresponding time-domain functions. This relationship, which is depicted graphically in Figure 1, illustrates the principle by which evoked potential energy is produced at the appropriate frequencies, whenever a repetitive, pulse-like stimulus produces a train of responses.

Given that linear superposition is occurring, it is natural to expect the appearance of a repetitive evoked potential that contains energy at the fundamental as well as the higher harmonics of the stimulus rate. Energy will appear at any harmonics at which the individual evoked responses contain energy. In the case of visual evoked potentials, two predominant energy bands are observed, one from 7 to 10 Hz, the other from 15 to 20 Hz (McGillem & Aunon, 1977; Moody, Micheli-Tzanoiakou, & Chokroverty, 1989). Therefore, by providing visual stimulation at the rate of 8.5 per second and filtering at 8.5 Hz and at 17 Hz, it is possible

Figure 1

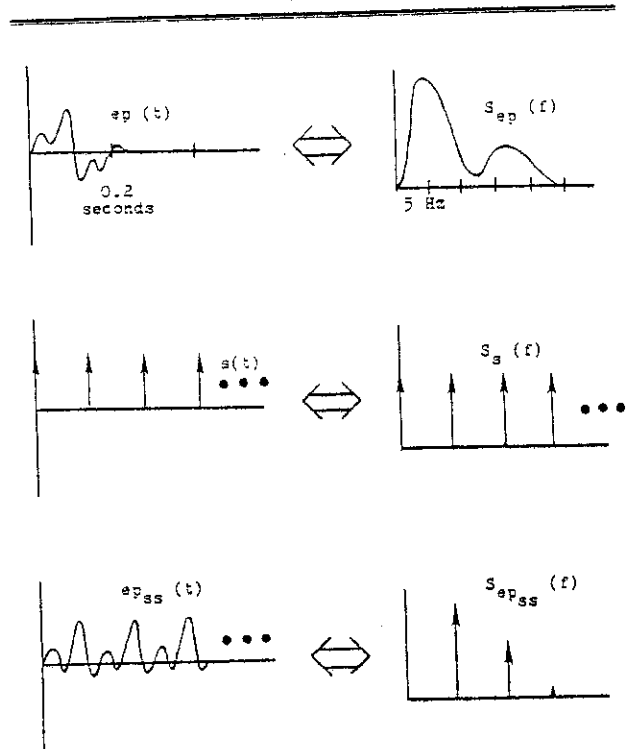

Time- and frequency-domain analysis of the generation of evoked potential harmonics via repetitive stimulation. Signals depicted for an 8.5-per-second visual stimulus rate. Left: time-domain; right: frequency-domain; top: single response; middle: stimulus train; bottom: repetitive evoked response. Symbols are explained in text.

to estimate the energy in each of these components separately, and in real time.

Additional support for the notion that these components may represent different brain processes is the observation from lesion studies that evoked potential morphology is selectively changed by specific traumatic loss of brain areas (Greenberg, Mayer, Becker, & Miller, 1977). It is thus reasonable to suppose that particular brain areas contribute particular components of evoked potential responses, and that these components may represent different stages of information processing. One purpose of this study was to look for independent variation in signal components, as well as different sensitivity to directed attention in the vigilance task. While the primary focus of this study was visual evoked potentials,

auditory evoked potentials were also measured, both to confirm previous results, and to provide a balanced experimental design.

### Methods and Material

The steady-state evoked potential paradigm facilitates the following features in the experimental design:

1) At all times during which data are taken, both auditory and visual stimuli are continually present.

2) At all times during which data are taken, the subject is demonstrably performing well in a difficult discrimination task.

3) There are no systematic differences between the paired task conditions with regard to external conditions, mental set, overall arousal level, or task difficulty.

4) The experiment can be paired and counter balanced to control for effects of boredom, arousal, and fatigue, and the total session is relatively short (less than 30 minutes).

Ten subjects ranging in age from 17 to 30 years participated in this experiment. All were male college undergraduate or graduate students, with no known neurological or psychological abnormalities or deficiencies. Each subject participated in two sessions one week apart, each session lasting 25 minutes. During each session, the subject sat in a comfortable chair wearing lightweight stereo headphones for auditory stimulation, and goggles fitted with light-emitting diodes for photic stimulation. Each session consisted of a brief instructional period followed by six 3-minute runs, separated by 30-second pauses. During each pause, stimuli were turned off and the subject rested.

Flashes were produced by 10-millisecond, 20-milliampere current pulses synchronized to the EEG filters, and presented through HP 5082-4550 light-emitting diodes. Within each run, binocular flashes were presented to both eyes at a rate of 8.5 per second; goggle separation was adjusted until subjects reported a single fused image. The flash amplitude was 0.0023 milliwatts

per eye, measured with an Eppley thermopile and Keithley 610C electrometer.

Clicks were produced by providing 1.4 volt peak-to-peak pulses to AKG K 140 stereo headphones. Binaural biphasic clicks (20 milliseconds total) were presented to both ears at a rate of 7.5 per second. The click sound pressure level was 88 dB at the ears, measured using a Bruel and Kjaer Type 2204 sound level meter equipped with a DB 0909 6cc artificial ear.

The EEG recorded from Cz was referenced to the right ear, with the left ear as ground. EEG was filtered using locked filters tuned to the fundamental and first harmonic of the stimulus rate, producing two separate output signals associated with each modality (8.5 and 17 Hz for visual, 7.5 and 15 Hz for auditory). Local oscillators controlled the stimulators as well as the filters, ensuring absolute frequency tracking (see Figure 2).

As a task to cause directed attention and to monitor subjects' attention and performance, the intensity of the stimuli could be selectively decremented by an amount of from 1.5 to 5.0 dB, at which point the subject was to signal by pressing a button that this decrement was detected. Upon making a correct detection, the subject was told, "That is correct," and a random interval of 10 to 40 seconds was introduced before another decrement was introduced. False detections were similarly fed back with the words, "That is false, just relax," and the run continued unchanged.

Decrements were started at 1.5 dB and increased until the subject could detect them, then were decreased until a decrement was missed, and so on (see Figure 3). Thus, decrements were maintained at the subject's discrimination threshold, providing an indicator of the sustained application of attention as the task continued. Each 3-minute run contained either an auditory or a visual vigilance task. The task order was designed to separate time effects from modality-specific effects, as shown in Figure

Figure 2  
Experimental configuration for this study

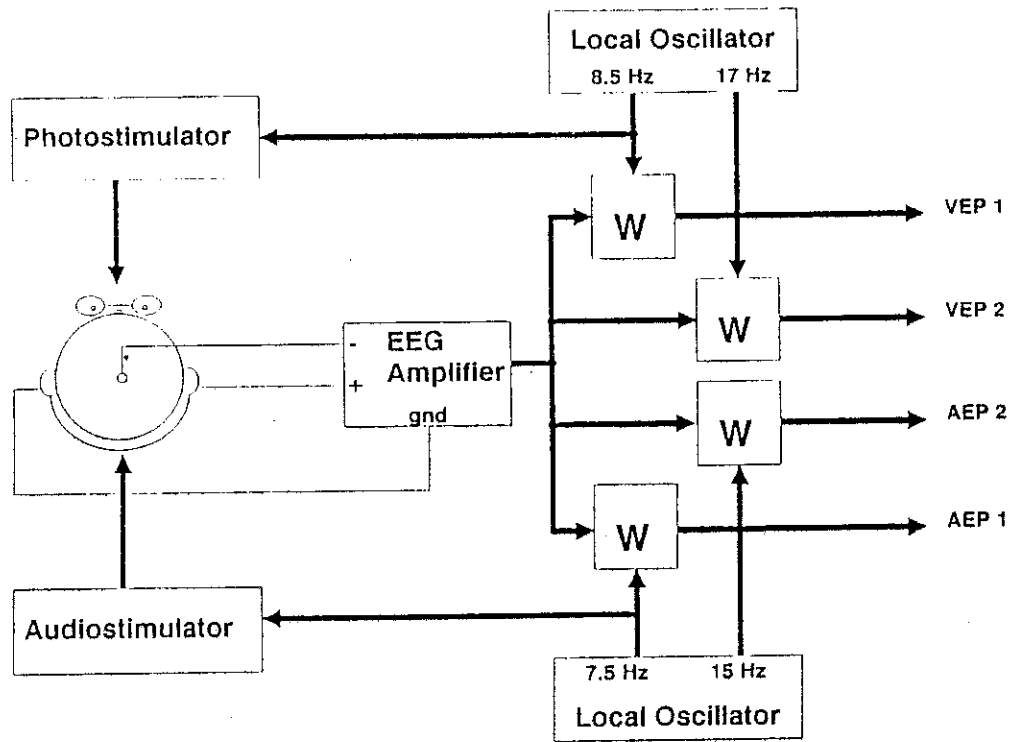

Local oscillators control both the stimulators and the EEG filters. The "Weaver Filter," described in Collura (1990), produces a controlled narrow band filter locked to the stimulus frequency.

Figure 3  
Progress of a typical run in the vigilance task

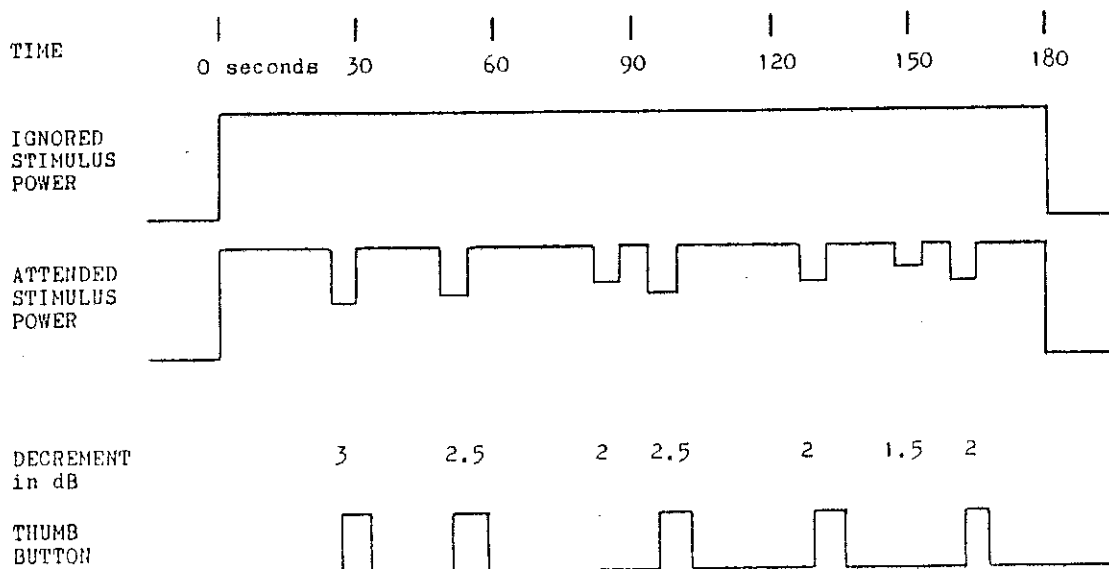

This illustrates how the size of the decrement is decreased until the subject misses one, then is increased, etc., maintaining the stimulus change at a near-threshold detection level.

Figure 4  
Arrangement of runs in a session.

	Run Number					
	1	2	3	4	5	6
Session 1	A	V	V	A	A	V
Session 2	V	A	A	V	V	A

Runs 1 and 2 are practice runs.

Time effects: compare 3 & 4 against 5 & 6.

Modality specific effects:

compare runs 3 & 6 against 4 & 5.

4, and uses an "ABBA" design (Plutchik, 1968).

Subjects were told at the beginning of the run which task was to be performed. Subjects were told to maintain the same gaze for each run, changing only their subjective attention as necessary to perform the vigilance task. Although only one modality was used for the task for each run, decrements were introduced randomly in both

modalities to control for possible effects of the decrements themselves on the evoked potentials.

Evoked potentials were measured as the peak-to-peak output of the synchronous filters. This provided a continual amplitude signal. The raw EEG for the entire session was visually reviewed for muscle, eyeblink, or movement artifact. No records containing such artifact were included in the study. Sample records from the two task conditions are shown in Figures 5 and 6.

The evoked potential results were analyzed as follows: The waveform data from the first 30 seconds of a run were discarded to remove the effects of filter rise-time, initial eye movements, and other transient events. The remaining 150 seconds were divided into three 50-second frames, and each frame was used to provide a maximum, minimum, mean, and standard deviation for each channel. For each frame, the evoked potential amplitude was sampled every two seconds, providing 25 values for the computation.

Figure 5

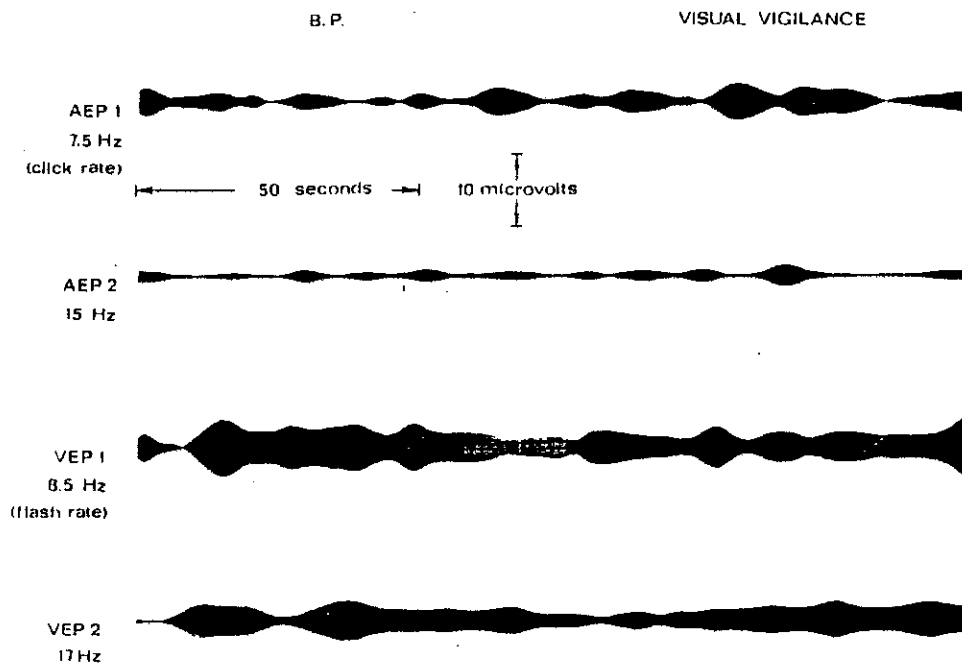

One subject's filter outputs for steady-state evoked potential components measured in this study: visual vigilance condition. Filter outputs consist of sine waves which, when plotted at slow chart speed, reveal characteristic envelopes which show time-variations in evoked activity. Components AEP1, AEP2, VEP1, and VEP2 are explained in the text.

Figure 6

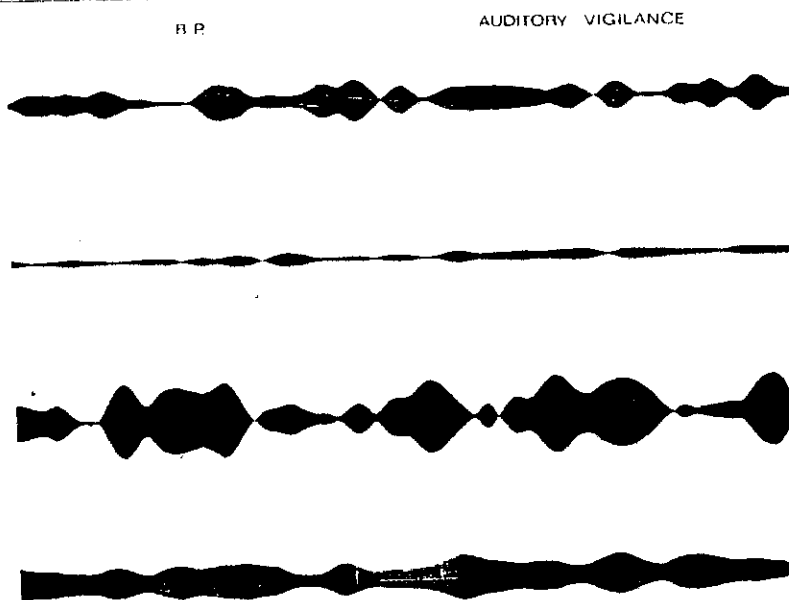

Same as Figure 5, except in the auditory vigilance condition.

Since it was desired to measure and investigate the variability as well as the amplitude of evoked potential components, the four statistics were treated as individual parameters, and each was tested for significant changes between runs. Each run thus

provided 3 estimates for each of the 4 statistics, for each of 4 evoked potential components (see Figure 7).

Results were then compared between runs as follows:

Runs 1 and 2 were discarded as practice runs. For modality specific effects, the six values for runs 3 and 6 combined were rank scored against the six values for runs 4 and 5 combined. For time effects, the six values for runs 3 and 4 combined were rank scored against the six values for runs 5 and 6 combined.

Wilcoxin rank sum scores were computed in order to compare runs. This method was used for several reasons. First, it is a nonparametric test, hence no assumptions must be made regarding the probability distribution of the data. As a result, the test is more robust, and more stringent; it is more difficult to obtain a given significance than using, for example, a t-test. Finally, it was of interest to study not only differences in means, but also differences in the maximum, minimum, and variance of the data. By allowing each 50-second epoch to provide an estimate for each of these parameters

Figure 7

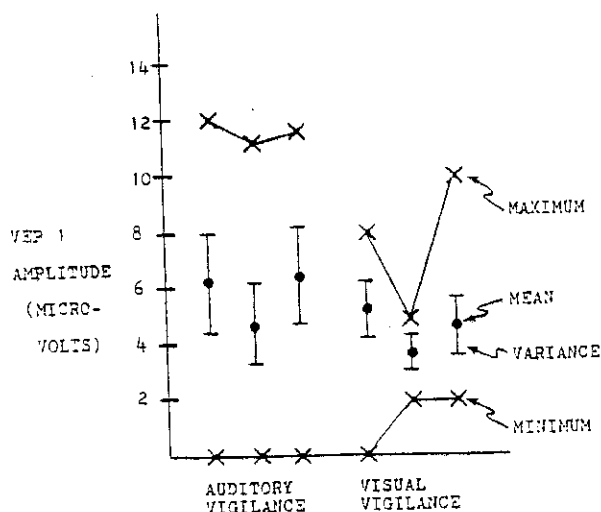

Typical values obtained from a pair of runs. Maximum, Mean, Variance, and Minimum values are obtained from each of three 50-second segments of each run.

and applying a nonparametric test, it is possible to look for changes in any of these parameters as a function of task condition.

Only scores with significance equal to or better than  $p=0.01$  are reported. A perfect ranking of six values in one condition all larger than the six values from the contrasting condition corresponds to a two-tailed  $p$  value of 0.0022. If one value from the larger group falls below the maximum value from the contrasting group, a  $p$  of 0.0044 is achieved. If two such values are out of place, a  $p$  of 0.0086 is achieved. Only results satisfying one of these conditions were included in the results section (Figure 8).

### Results

Short-term variations in evoked potentials were observed in all subjects. Components were observed to vary independently of each other, revealing distinct patterns of waxing and waning. This suggests significant mechanisms which underly the variability of averaged evoked potentials, and highlights the limitations in using a single wave estimate which represents more than about 10 seconds.

Figure 8

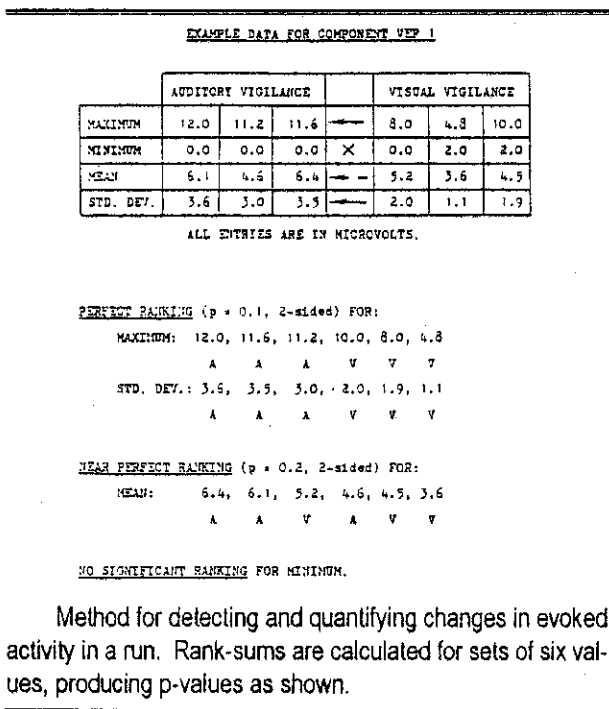

None of the auditory evoked potential components reached significance of  $p<0.01$ . This is consistent with Linden et al. (1987).

The results of this scoring are summarized in Tables 1 and 2. Not all subjects produced significant changes in evoked potential amplitudes as a function of task condition. Seven of the 10 subjects showed significant changes in evoked potentials, but only 6 of 10 showed modality-specific changes. Four subjects had visual evoked potentials larger in the visual vigilance condition. In two subjects, both VEP components were found consistently higher in the visual vigilance condition. This result was found in both sessions.

### Discussion

Table 1  
Component VEP1

Subject	Session	Max	Min	Mean	Var
D.S.	1				
	2				
B.H.	1				
	2				
B.P.	1				
	2				
R.M.	1				
	2				
K.S.	1		V	V	
	2	V	V	V	
M.R.	1	V	V	V	
	2	V	V	V	
R.B.	1				
	2				
D.P.	1				
	2	T			
J.H.	1				A
	2	A			
J.W.	1				
	2				

Table 1. Significant ( $p<0.01$ ) trends found in steady-state visual evoked potential component VEP1 (stimulation 8.5 per second, component at 8.5 Hz). V=larger component during visual task; A=larger component during auditory task; T=component changed across time.

Table 2  
Component VEP2

Subject	Session	Max	Min	Mean	Var
D.S.	1				
	2				
B.H.	1		V	V	
	2				
B.P.	1	A		A	
	2				
R.M.	1		A	A	
	2		T	T	
K.S.	1	V	V	V	
	2	V	V	V	
M.R.	1	V	V	V	
	2		V		
R.B.	1				
	2				
D.P.	1	T		T	T
	2				
J.H.	1				
	2				
J.W.	1			A	
	2			V	

Table 2. Significant ( $p < 0.01$ ) trends found in steady-state visual evoked potential component VEP2 (stimulation 8.5 per second, component at 17 Hz). Legends same as for Table 1.

It is not clear whether or not all subjects employed the same "strategy" in performing the selective vigilance task; it is possible that individual differences in the approach to the task resulted in differences in evoked potential findings. It may be that this technique is sensitive to differences in individual "style," and that such individual differences produce some of the observed disagreement between results.

The primary conclusion from this report is that it is possible to detect short-term variations in steady-state evoked potentials, and that steady-state visual evoked potentials can exhibit sensitivity to changes in directed attention. While this finding is not shared by all subjects, those subjects that showed this sensitivity had repeatable results in two sessions. In addition, changes

across time can be detected.

It may be significant that more sensitivity was found in component VEP2 rather than VEP1. Given the fact that these components were observed to wax and wane in an apparently independent fashion, they may be representative of somewhat different stages in visual information processing. The independence of these response components, combined with the notion that they normally combine to produce the conventional multiphasic evoked potential, challenges the concept of specific evoked potential peaks and valleys as fundamental elements of brain response. Rather, any specific maximum or minimum may be produced by the combination of a variety of brain responses, which produce the appearance of a single peak.

While short-term variations in evoked potential components were observed, this study did not attempt to correlate them with short-term changes in task performance. This would appear to be an important area for future study. If such correlations are found, they could provide a basis for real-time monitoring of dynamic processes in attention and alertness. Such a capability could be important in both research and clinical applications.

### References

- Childers, D. G., & Perry, N. W. (1971). Alpha-like activity in vision. *Brain Research, 25*, 1-20.
- Collura, T. F. (1978). Real-time evoked potential correlates of directed attention. *Proceedings of the 31st Annual Conference on Engineering in Medicine and Biology, 10*.
- Collura, T. F. (1987). A transient-event model for EEG power spectra. *Proceedings of the 40th Annual Conference on Engineering in Medicine and Biology, 247*.
- Collura, T. F. (1990). Real-time filtering for the estimation of steady-state visual evoked brain potentials. *IEEE Trans-*



*actions on Biomedical Engineering*, 37(6), 650-652.

- Collura, T. F., & Lorig, R. J. (1977). Real-time filtering of transient visual evoked potentials. *Proceedings of the 30th Annual Conference on Engineering in Medicine and Biology*, 61.
- Greenberg, R. P., Mayer, D. J., Becker, D. P., & Miller, J. D. (1977). Evaluation of brain function in severe human head trauma with multimodality evoked potentials. *Journal of Neurosurgery*, 47, 150-177.
- Kinney, A. S., McKay, C. L., Mensch, A. J., & Luria, S. M. (1973). Visual evoked responses elicited by rapid stimulation. *Electroencephalography and Clinical Neurophysiology*, 34, 7-13.
- Linden, R. D., Picton, T. W., Hamel, G., & Campbell, K. B. (1987). Human auditory steady-state evoked potentials during selective attention. *Electroencephalography and Clinical Neurophysiology*, 66, 145-159.
- McGillem, C. D., & Aunon, J. I. (1977). Measurements of signal components of single visually evoked brain potentials. *IEEE Transactions on Biomedical Engineering*, BME-24, 232-241.
- Mendenhall, W. (1971). *Introduction to Probability and Statistics*. Belmont, CA: Duxbury.
- Moody, E. B., Jr., Micheli-Tzanoakou, E., & Chokroverty, S. (1989). An adaptive approach to spectral analysis of pattern-reversal visual evoked potentials. *IEEE Transactions on Biomedical Engineering*, BME-36, 439-447.
- Naatanen, R. (1975). Selective attention and evoked potentials in humans—a critical review. *Biological Psychology*, 2, 237-307.
- Plutchik, R. (1968). *Foundations of Experimental Research*. New York: Harper & Row.
- Regan, D. (1989). *Human Brain Electrophysiology: Evoked Potentials and Evoked Magnetic Fields in Science and Medicine* (pp. 41-42). Amsterdam: Elsevier.
- Spong, P., Haider, M., & Lindsley, D. B. (1965). Selective attentiveness and cortical evoked responses to visual and auditory stimuli. *Science*, 148, 395-397.
- Thakor, N. (1987). Adaptive filtering of evoked potentials. *IEEE Transactions on Biomedical Engineering*, BME-34, 6-12.
- van Hof, M. W. (1960). The relation between the cortical responses to flash and to flicker in man. *Acta Physiologica Pharmacologica Neerlandica*, 9, 210-224.

Thomas F. Collura received an AB in Philosophy of Science and an Sc.B. in Biology from Brown University, Providence, RI in 1973. He received an M.S. and Ph.D. in Biomedical Engineering in 1977 and 1978, from Case Western Reserve University, Cleveland, OH. Since then, he has developed several generations of analog and digital EEG instrumentation. He has held staff positions with AT&T Bell Laboratories in the areas of semiconductor and systems engineering, and at the Cleveland Clinic developing long-term EEG monitoring systems for neurology. Dr. Collura is the developer of the BrainMaster digital EEG, and is currently a consultant in medical and industrial software and systems engineering. His long-term research interests are in the applications of brain monitoring and interactive computer graphics, to further the development of an objective science of the mind. This work was supported in part by NIH Training Grant GM-01090-14.

Address correspondence to: Dr. Thomas F. Collura, P.O. Box 23646, Chagrin Falls, OH 44023.